

PICOMAX® 823/825 VER3A Dynamics and Performance on Top Level.



VER3A

PICOMAX® 823/825



FEHLMANN: The Brand.



Precision «Made in Switzerland».

*At FEHLMANN, the customer will receive everything from a single source!
The high quality standard covers the entire production process and is reflected in all our products.*

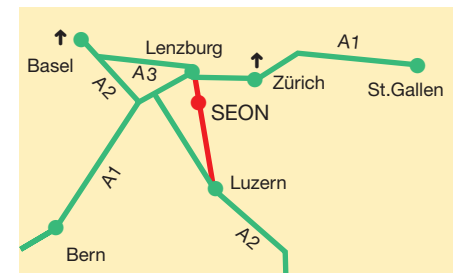

Development, production and assembly are carried out exclusively in the main plant at Seon, Switzerland by more than 180 staff members. Trained and specialised FEHLMANN staff as well as local representations constitute our customer service.

Experts mention as outstanding features: maximum precision, ergonomics, reliability and handiness. By quality, however, FEHLMANN also understands the development of machines coming up to the actual requirements in the workshop.

We have the experience in practical operation.

The PICOMAX® 825 and 823 VERSA.

Precise, reliable, compact.

The PICOMAX 825 VERSA for optimized 5-axis machining of complex work pieces, dynamic HSC milling as well as for processing difficult-to-machine materials.

The PICOMAX 823 VERSA for precise and dynamic 3-axis high performance machining of large work pieces weighing up to 1,000 kg max.

The customer is also offered a wide variety of options to tailor the machine to his particular requirements. As you are accustomed to with FEHLMANN, these machines as well are equipped with all features required for high-accuracy machining and can easily be retrofitted with automation at any time.



4 **Geometry and configuration**

5 **Spindles custom-tailored**

6 **Precise 5-axis milling**

7 **3-axis milling up to 1,000 kg**

8 **Control and software**

9 **44 to 218 tools**

10 **Dry or wet machining**

11 **Floor plan, technical data**

12 **Automation**

The concept at a glance:

- Accessible from three sides
- Compact, small footprint
- Flexible in terms of automation



Ergonomics with and without automation

The work piece is situated at the optimum working height and can be simply loaded by crane through the overhead opened telescope-doors.

Custom-tailored configuration of coolant equipment and peripheral devices, depending on the space available at the site: In combination with the tenfold pallet changer, the cooling unit, the high-pressure system and the chip conveyor may for instance be arranged on the left side behind the pallet changer.



Application:

- For milling complex work pieces from titanium and aluminium, e.g. in the aerospace industry.
- For milling hardened tool steels in mould and die making.
- For machining stainless steels in medical engineering and for demanding parts in general machine and vehicle manufacturing.

Access from the right:

Free access to table and tool changer, the operator remains close to milling process and laser (option) for automatic tool measurement.

Access from the front:

Even when swivelling the swivel bridge away from the operator, nothing obstructs the view on spindle and bridge - nothing escapes the operator.

Access from the left:

This side may be equipped with an automatic door and is reserved for any automation system to be retrofitted later on.



Compact, accessible intelligent design.

The VERSA concept - patent-registered - of FEHLMANN is not only space saving, it also grants the extremely safe and fast operation of the machine and is easily automated.

From his operating stand, the operator has all important areas of the machine under control. In order to monitor the machining process from the front and for loading the automation, you may easily rotate the control unit by 90° (see figure).

This not only saves time but also reduces the risk of operating errors.

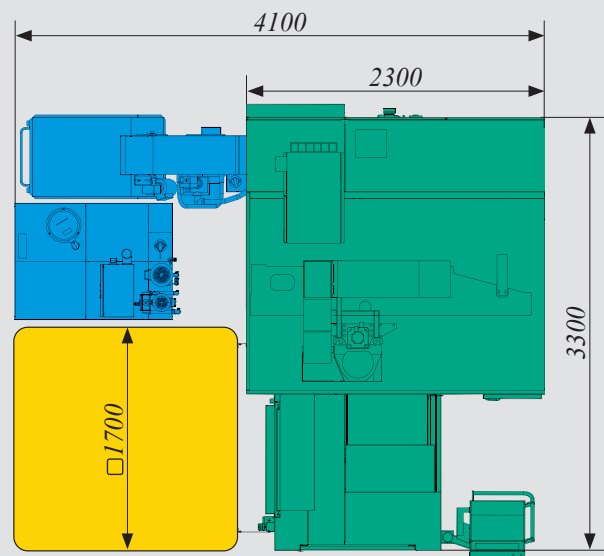

Example with high-pressure internal cooling and pallet changer. Green: machine
Blue: periphery/coolant equipment / Yellow: automation

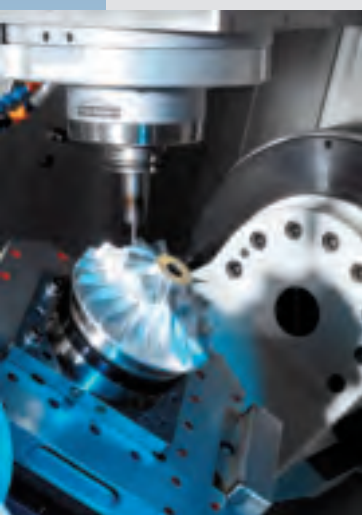

Precise, hand-scraped machine geometry and stability-optimized structure.

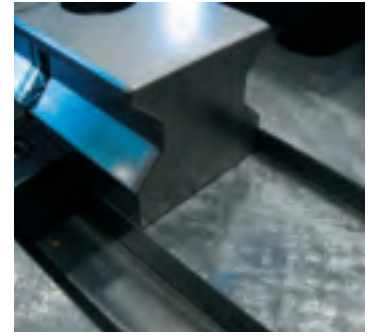

Optimized machine structure.

The FEM and topology-optimized machine structure in portal design is based on a 3-point support and made from grey cast iron. Selecting this material offers excellent advantages, like homogenous heat conductance, optimum dampening characteristics and good dimensional stability. In order to achieve more rigidity hand in hand with a higher accuracy in the tool axis, only 2 axes (Y and Z) for the tool movement were realized on purpose. Widely supported guide slides as well as ball screws with cooled drive units grant fast axis feeds and acceleration for a viable and highly accurate high performance machining.

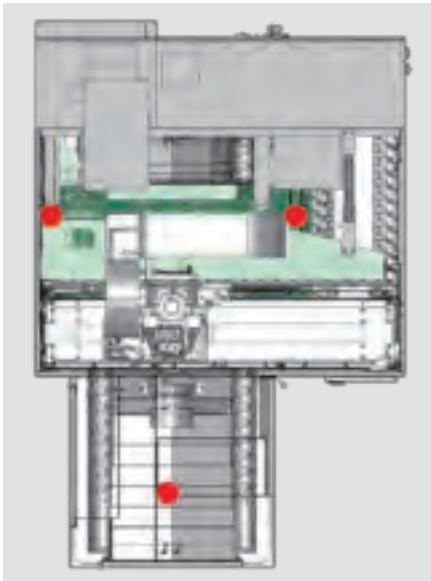
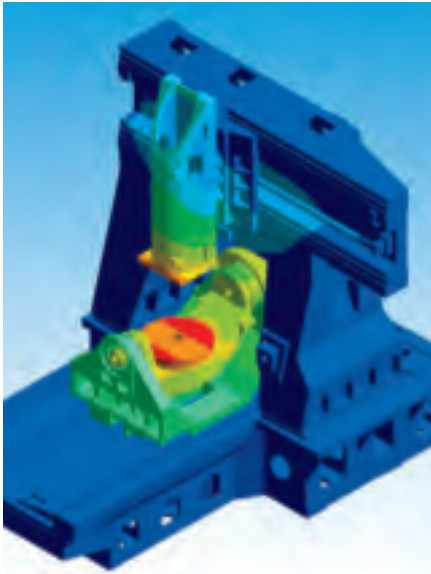

Thermal stability.

Precision linear guide ways with direct measuring system in all axes. All elements prone to introduce heat to the machine are actively cooled and are insulated from the machine frame. For instance, the drive units are cooled and the interior of the machine is lined with sheets from stainless steel. The machine comes standard equipped with thermal compensation; by request, position compensation using the direct axis measuring system is also available. This is why the PICOMAX 825 and 823 VERSA quickly achieve operating temperature and offer constant 24-hour accuracy as well as maximum geometric precision.

Precise machine geometry

Guide ways and machine geometry are hand-scraped; in this way, the geometry may be optimized at the machine frame without any electronic compensation.



Swivel bridge with 6 guide carriages.

The swivel bridge is supported over the entire machine length using generously dimensioned roller guides. For more rigidity and optimized vibration dampening, the system is fitted with two additional guide carriages (adding up to three carriages per side).

Large swivel range of 230° (+/-115°).

The dividing, swivelling table disposes of cooled torque drives and is integrated into the machine concept in longitudinal direction; this makes the swivel axis rotate around the machine bed axis X plunging into the solid portal in milling applications. Thanks to this configuration, any kinetic coupling (the build-up of the swivel axis to become a linear axis during simultaneous milling) is thus systematically excluded. At the same time, this design gives all-around access to the work piece.

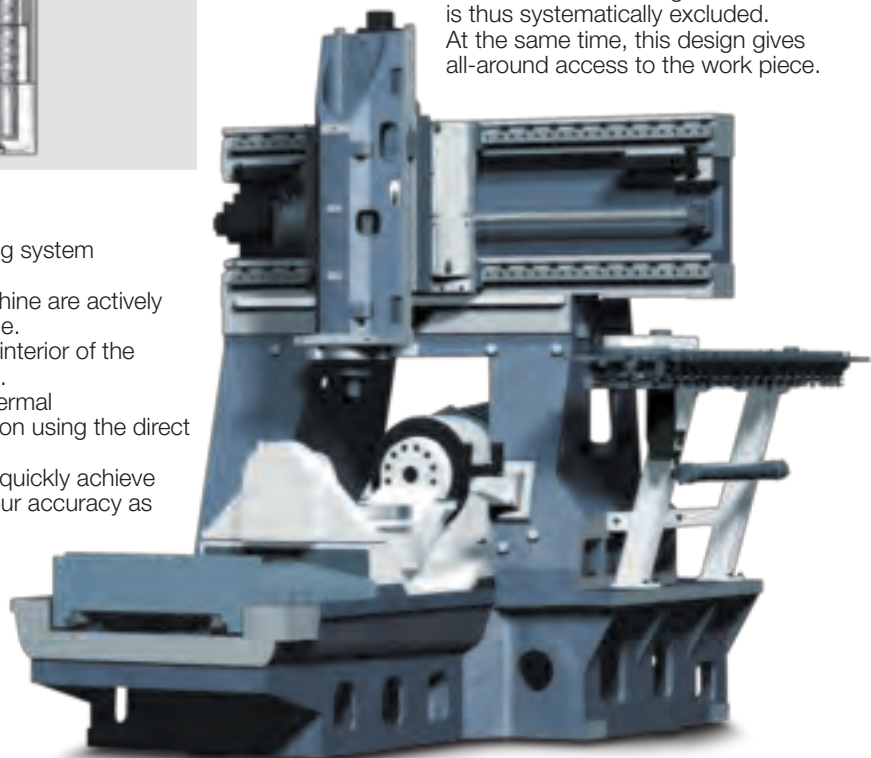

Leading-edge technology for the most complex machining tasks.

Spindles for outstanding results.

Depending on the specific customer's requirements, the machines can be delivered with various HSC motor spindles. Whether with HSK-A63 and 14'000 or 20'000 rpm or with HSK-E50 and 30'000 or 36'000 rpm - all spindle types grant low-vibration and precise concentricity for best surfaces and maximum tool life. Next to the high speeds, all spindle types have been designed for the use of conventional tools and optimal cutting data regarding torque and mechanical configuration.

This minimizes programming work and increases the customer's flexibility. The standard cooling system is supported by thermal compensation and helps to achieve constant machining results.



In-house motor spindle production.



True to the motto "Everything from a single source", FEHLMANN has always designed and built the motor spindles itself since 1996. Today, the reliable and universal FEHLMANN spindles are running at numerous satisfied customers.



Active spindle cooling. For optimum thermal stability, all spindle types are equipped with an active spindle cooling system as standard. Depending on the spindle type, also a position compensation system for the main spindle using the direct axis measuring system is available as an option.

PICOMAX® 825 VER3A: Dynamic, high-precision 5-axis milling.



Direct-drive dividing, swivelling table.

Is able to symmetrically swivel work pieces on two sides.

Thanks to the smart layout of the operating panel, the operator never loses track of any operation.

Dynamic and robust.

The cooled torque drives of the dividing, swivelling table are specially designed for fast 5-axis simultaneous milling as well as for high-precision 5-axis milling with positioning.

Highest geometric precision and stability.

Long years of experience in high-accuracy 5-axis milling have had a significant impact on the development of this swivel bridge. The double support prevents the table from sagging at the front. The automatic clamping system is designed in a way that any position offset can be excluded.

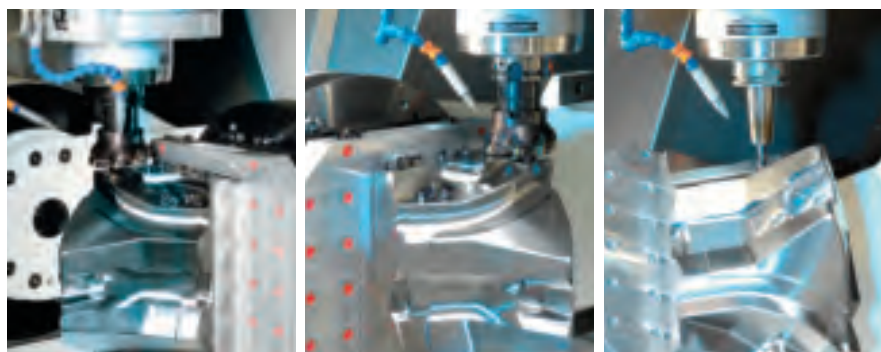
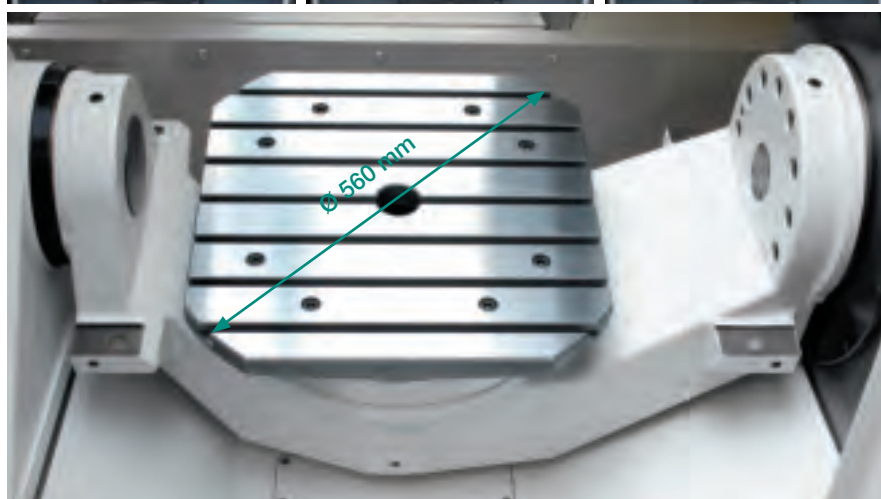
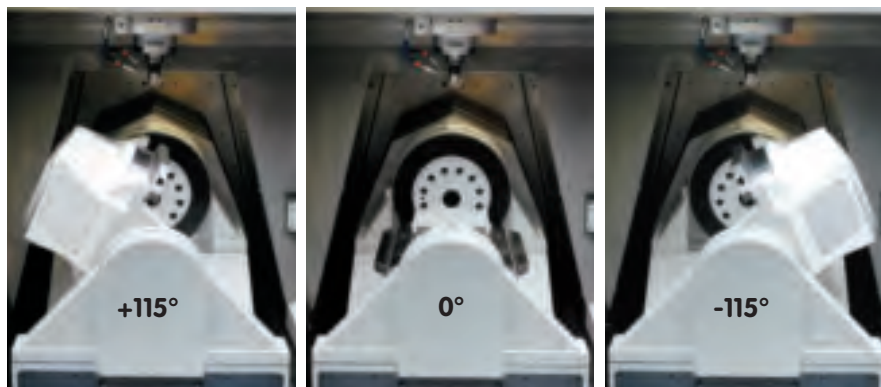

Various jigs and fixtures available.

On customer request, virtually all standard chuck system may be integrated instead of the universal table (see figure).

The sophisticated configuration of the rotary feedthrough permit easy installation of the most varied clamping systems.

Please contact us if you do not see the system you need in the figures; we shall be glad to help you work out your perfect solution.



Working with barrel.

The pneumatic barrel may be controlled automatically and can thus easily be integrated in an automation system.

It can be dismantled or adjusted in a simple way at any time.

Max. interference contour for unlimited 5-axis milling.

By limiting the rotating and swivel range, also larger work pieces may be machined.

The max. work piece dimensions depend on the milling strategy and the fixtures and may thus deviate from the max. interference contour.

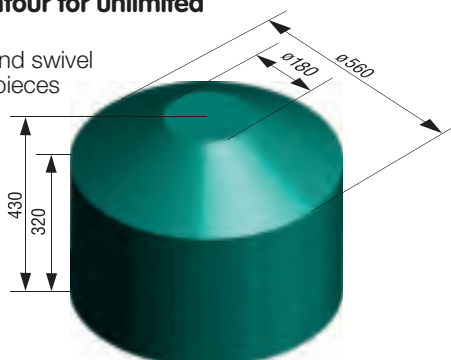

PICOMAX® 823 VERSA: 3-axis model for work pieces up to 1,000 kg.

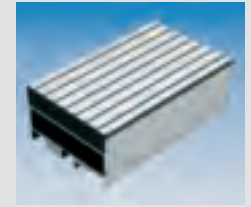

4-axis design possible.
As an option, dividing units in different sizes are available for the PICOMAX 823. (Option)



Perfectly suited for the machining of high-precision machine components and mould bases up to 1,000 kg.

The FEHLMANN PICOMAX 823 VERSA allows for precise and dynamic high-performance machining of large work pieces weighing up to 1,000 kg max.

High-precision 3-axis machining.

Like the swivel bridge, also the table plunges into the portal during the machining process. This concept has particularly been designed for complex and/or high-precision 3-axis machining tasks with optimized surface finish.

Ample space.

The table supports weights up to 1,000 kg. A large table surface of 1,200 x 750 mm is available to the operator which also qualifies for machining applications with multi-part clamping.

Clever: Solutions for working with multi-part clamping.

The use of a clamping plate offers the operator a generous table surface of 650 x 580 mm - the perfect solution for working with multi-fixtures. Clamping plate and swivel bridge are designed in a way that installed chucks must not be removed. This saves time and reduces non-productive times (clamping plate available as an option).

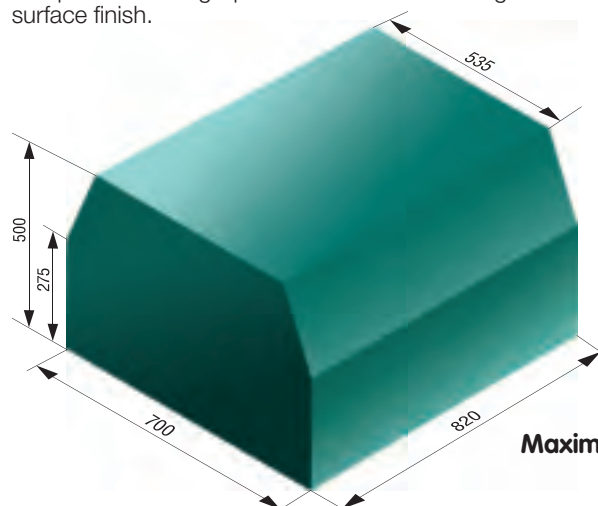

Maximum interference contour.

Control and software: For high-speed and high-quality work.

The fully-digital Heidenhain control is equipped as standard with the Heidenhain software options 1 and 2 (functions for 5-axis-machining and fast HSC-milling), the electronic hand wheel as well as the FEHLMANN cycle HSC-Setup™.

Integrated machining cycles (standard), graphical support and the integrated hard disk combined with fast block processing make the PICOMAX 823/825 rise to virtually all workshop requirements. From the complex 3-axis and 5-axis CAD/CAM program up to the simple mechanical component programmed right at the machine.

(The monitor text may be switched into many different languages. Please see the TNC-brochure for more details.)



- Free contour programming in case of insufficiently dimensioned contours.
- Heidenhain conversational programming and DIN/ISO programming possible.
- Swivel cycles support the programming of the 4th/5th axis.
- Integrated hard disk for the transmission of 3D programs of almost unlimited length.
- Fast-Ethernet Network Interface for high-speed data transmission from external programming stations.
- New FEHLMANN specific diagnosis system for speedy troubleshooting.
- DXF converter for reading DXF contours (option).
- FEHLMANN HSC-Setup™.
- Smart NC.

Please, ask for the detailed control brochure.

Weight-optimized simultaneous milling.

FEHLMANN cycle ARO™-Automatic Rotary-Axis Optimization. Standard: Cycle for optimizing the dividing/swivelling axes depending on the weight of the milled part. The cycle differentiates between three weight classes and influences the control of the dividing/swivelling axes depending on the class.

Minimizing risk of collision.

Option: the active collision inspection supports the operator in prevent collisions caused by operating or programming errors. Tools and clamping fixtures are stored in the control. If the control detects a potential collision it may decelerate or even stop the feed.

Automatic determination of the rotation centres.

Option: 'KinematicsOpt.' determines the rotation centres of your machine accurate to one thousandth of a millimetre - in an easy and simple way. The ball-tipped probe required for the cycle is included in the delivery scope of this option. (Only operable if combined with the option 3D touch probe.)

3D touch probe system.

With infrared signal transmission for zero point setting as well as for part measurement functions. Automatic run-out compensation thanks to 360° probe radius.



Ergonomic working environment.

The height-adjustable operating panel can individually be adjusted to the operator's size. The handheld control unit with the electronic hand wheel and the compressed air gun are standard equipped on the operating panel and always within the operator's grasp.



Extended power save function.

Automatic standby of the machine drives after completely processing the NC programs. Via the electronic timer, the system can automatically be powered up again. This allows for the unattended warm-up of spindle and axes (option).

Tool magazines: Between 44 to 250 tools.

In order to minimize set-up times,
the tool changer and the table may be
loaded from the same side.



Standard tool capacity: 44.

The machine picks up its tools from the chain and also restores them to the chain in short time. The tools may be inspected or replaced during the machining process.

The desired tool may be called at the control with just a few entries - and almost at cyber speed, the chain positions it in front of the loading door. This grants a perfect survey of the entire sequence at all times.



Optional tool capacity: 80.

Principally identical to the standard version, this chain offers a capacity for 80 tools.

Fast, efficient and accurate tool measurement.

For the non-contact tool measurement and breakage control right at the machine. Length and diameter of stationary or rotary tools from $D=0.6\text{mm}$ to $D=150\text{mm}$ may be measured with μm accuracy.

The determined measuring values are directly stored in the central tool memory of the TNC; the tool is cleaned using the integrated nozzles before each measurement. Instead of the laser system a mechanical control equipment is available. Of course both devices are integrated in the machine in an unobstructed way so that they can always be monitored by the operator. (Option)

Optional tool capacity: 186/218/250.

This rack magazine is designed in a way that the operator is able to inspect the tools from the outside at any time. Depending on the tool length, it adopts up to 218 tools (in case of extremely short tools even up to 250) and is loaded using an external loading unit.

The tools are positioned in a transfer station with double gripper which loads the tool in or unloads it from the spindle.



For dry or wet machining, various systems are available.

To come up to the different requirements, FEHLMANN even offers several coolant equipments.

These systems reach from the simple standard coolant equipment with chip drawer up to the high-pressure system with 80 bar internal cooling.

Standard coolant equipment with chip drawer, comprising:

Raising unit incl. chip drawer, bag filter, clean coolant tank, coolant pumps for bed flooding and external cooling. Capacity 280 litres, pump pressure 6 bar.

The ideal system for customers with predominantly dry machining tasks. The chips are fed into a drawer via a bed flooding system and can easily be discharged manually.

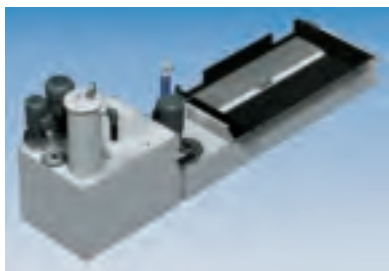

Coolant equipment with chip conveyor and bag filter, comprising:

Chip conveyor (scraper belt), bag filter, clean coolant tank, coolant pumps for bed flooding and external cooling, automatic activation of the coolant circulation during the weekend (switches on after coolant equipment has been at a stand-still for two hours).

Capacity 700 litres, pump pressure 6 bar. Additionally available with 40 bar or 80 bar high-pressure pump for internal cooling (each controlled via M functions).



Coolant equipment with chip conveyor and compact filter, comprising:

Chip conveyor (scraper belt), compact band filter, clean coolant tank, coolant pumps for bed flooding and external cooling, 80 bar high-pressure pump for internal cooling controlled via M functions.

Capacity 1050 litres, pump pressure 6 bar. This coolant system is exclusively designed for emulsions.



Conveying twist in machine base (option).

The chips are discharged backward into the chip bucket or chip conveyor via two channels located below the table on the right and the left side. Instead of the standard bed flooding, also conveying twist are available for large chip volumes as an option.



Customer-optimized layout.

The intelligent machine design allows the customer to either install chip conveyor and coolant system on the right or left side of the machine depending on the shop floor conditions and the selected configuration.

Coolant gun for manual cleaning.

The coolant gun for manually cleaning the machine is mounted to the housing close to the operator and is included in standard delivery.

Coolant shower.

Additional coolant nozzles below the machine roof support the chip discharge out of the machine. (Option)



Oil mist absorber system.

Machining processes using high speeds produce oil mist which spreads and deposits inside the work envelope. Thanks to efficient extraction, the interior of the machine is kept clean and at stable temperature. (Option)



Visiport spin window.

Mounted to the front window of the machine. In case of wet machining with coolant, the Visiport window ensures excellent view inside the working area. (Option)

Cooling equipment for coolant media.

If wet machining tasks require maximum precision, the coolant may additionally be cooled, especially when using oil. (Option)

Minimal lubrication system.

Economical cooling lubricant system. Perfectly suited for milling or heavy-duty cutting in materials like aluminium, copper and hardened steels. The device comes equipped with two nozzles and is activated/deactivated via M-functions. (Option)

Technical data

PICOMAX® 823/825VERSA

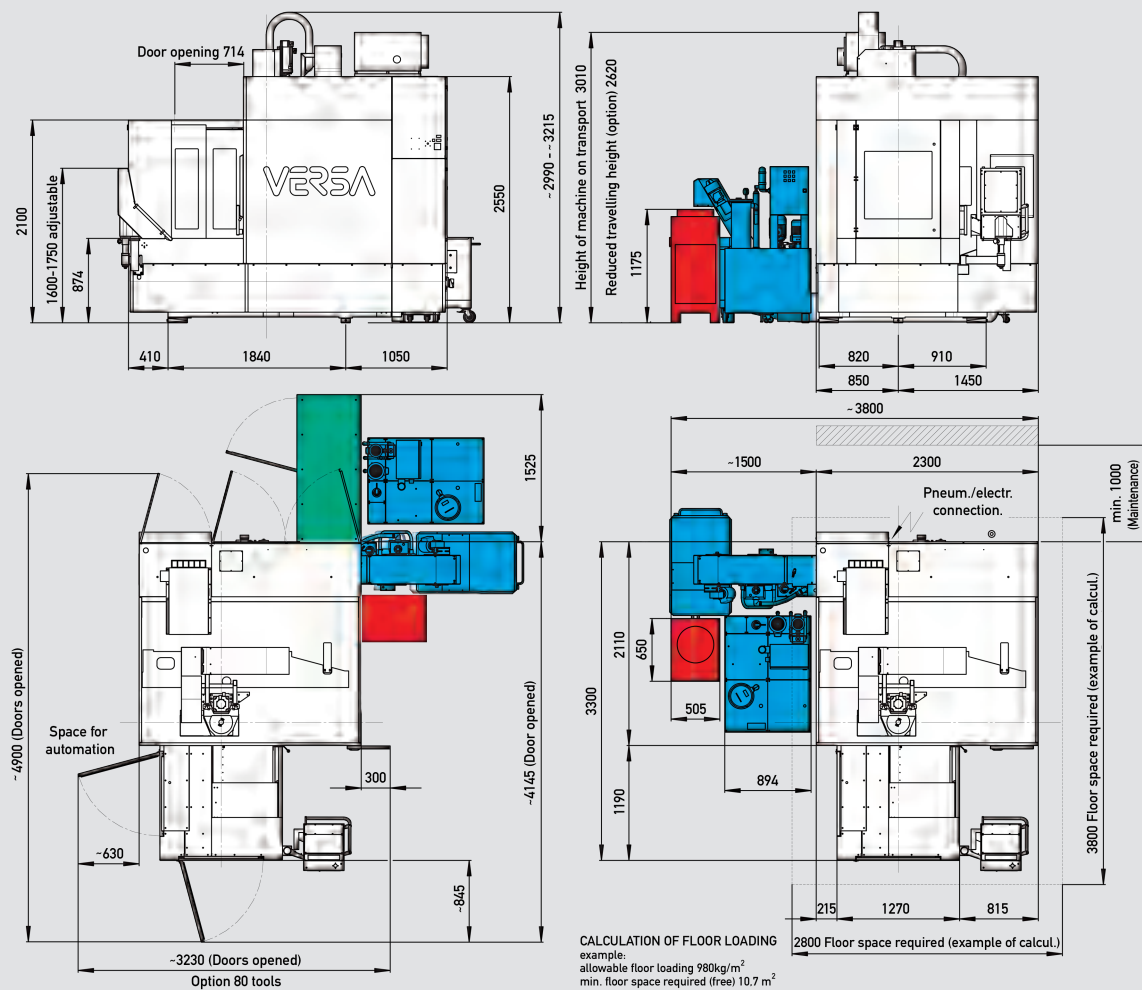

Height of automatic door (option) 2650 mm

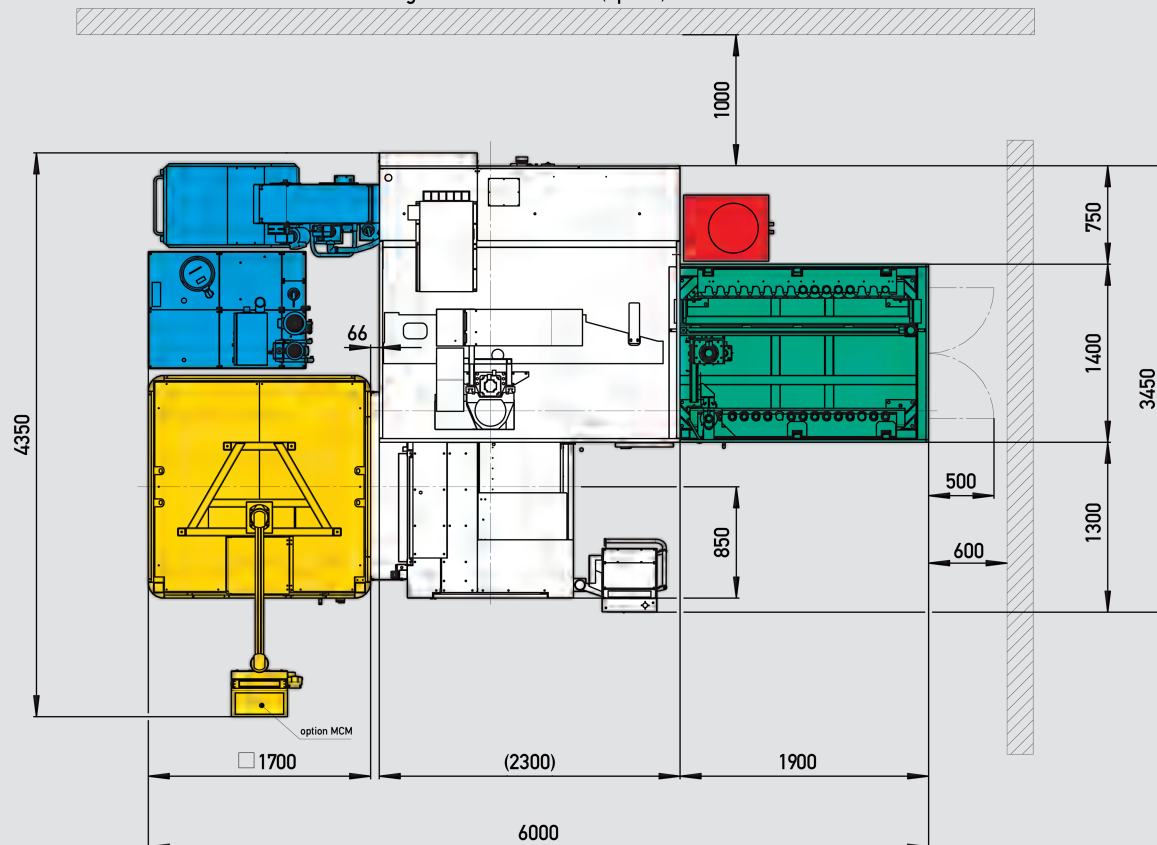

Example:
Machining cell with tenfold pallet changer and rack magazine with 218 tools.

Machine type		P 823	P 825
Travels			
X travel	mm	820	820
Y travel	mm	700 (1,270)	700 (1,270)
Z travel	mm	450	450
Dividing axis C	degrees		0-360°
Swivel axis A	degrees		230° (+/- 115°)
Table/work area			
Clamping surface (length x width)	mm	1,200x750	460x460
T-slots (width/distance/number)		14-H8/ 100/ 7	12-H8/ 63/ 7
Max. table load	kg	1,000	350
Distance between table and spindle nose	mm	150-600	120-570
Tool changer			
Magazine capacity, standard (no. of tools)		44	44
Magazine capacity, optional (no. of tools)		80/186/218/250	80/186/218/250
Max. tool diameter without empty pockets	mm	Ø 80	Ø 80
Max. tool diameter with empty pockets	mm	Ø 130	Ø 130
Max. tool length (from spindle nose)	mm	350	350
Tool changing time	sec	approx. 4	approx. 4
Mean chip-to-chip time	sec	approx. 8	approx. 8
Max. tool weight	kg	5 (8)	5 (8)
Feed rates			
Feed rate X / Y / Z	mm/min	1-30,000	1-30,000
optional	mm/min	1-48,000	1-48,000
Dividing axis C	°/min		1-21,600
	rpm		0-60
Swivel axis A	°/min		1-10,800
	rpm		0-30
Acceleration			
Acceleration X / Y / Z	m/sec ²	10	10
Acceleration C	rad/s ²		44
Acceleration A	rad/s ²		40
Clamping system			
Holding torque of clamping system Dividing axis C	Nm		1500
Holding torque of clamping system Swivel axis A	Nm		3200
Positioning accuracy VDI/DGQ 3441			
Positioning tolerance P			
X / Y / Z	mm	0.005	0.005
Dividing axis C	°		0.005
Swivel axis A	°		0.005
Positioning range Ps			
X / Y / Z	mm	0.003	0.003
Dividing axis C	°		0.003
Swivel axis A	°		0.003
Measuring systems			
Direct measuring system in all axes			
Pressurization		incl.	incl.
Power supply			
Operating voltage and frequency	V/Hz	3x400/50	3x400/50
Connection power (apparent power)	kVA	22	25
Recommended pre-fuse	A	63 AT	63 AT
Control voltage	V	24 DC	24 DC
Pneumatics, operating pressure	bar	6	6
Weight			
Machine tool (excl. coolant)	kg	~ 10500 / 44 tools	~ 10700 / 80 tools
		~ 11500 / 218 tools	

Subject to technical modifications.

Spindles

Speed range	rpm	50-14000
Tool holder		HSK-A63 (DIN 69893)
Repeatability	mm	0.002
Spindle power at S1 (100% ED)	kW	18.5
Spindle power at S6 (40% ED)	kW	24
Max. torque at S6 and nominal speed	Nm	120
Nominal speed	rpm	1920

Speed range	rpm	50-20000
Tool holder		HSK-A63 (DIN 69893)
Repeatability	mm	0.002
Spindle power at S1 (100% ED)	kW	18.5
Spindle power at S6 (40% ED)	kW	24
Max. torque at S6 and nominal speed	Nm	120
Nominal speed	rpm	1920

Speed range	rpm	50-30000
Tool holder		HSK-E50 (DIN 69893)
Repeatability	mm	0.002
Spindle power at S1 (100% ED)	kW	11.5
Spindle power at S6 (40% ED)	kW	15
Max. torque at S6 and nominal speed	Nm	33
Nominal speed	rpm	4360

Speed range	rpm	50-36000
Tool holder		HSK-E50 (DIN 69893)
Repeatability	mm	0.002
Spindle power at S1 (100% ED)	kW	15.6
Spindle power at S6 (40% ED)	kW	17.8
Max. torque at S6 and nominal speed	Nm	15
Nominal speed	rpm	11650

Subject to technical modifications.

FEHLMANN-Automation: 24-hour-Efficiency.

Everything from a single source.

The automation is matched to the customer's individual requirements with regard to pallet capacity, number and design of the axes etc. At customer's option, it may completely be assembled and tested at FEHLMANN or can be installed at the customer's location. This prevents interface problems and the customer can count on an operable and functioning machine right from day one.

From single or two-machine solutions (one automation loads two machines) up to the installation to a linear automation system. The PICOMAX 823 and 825 VERSA are designed in a way that they can be adapted to the most varied automation concepts. It goes without saying that an automation may be retrofitted at any time.

The automation follows a logic design and is installed to the side so that it does not interfere with the operator at all. *Please, ask for our detailed automation brochure!*



Simple control via MCM™ (Milling Centre Manager) or pallet management file.

Depending on the number of pallets and the variety of parts, the system can be controlled and monitored by a pallet file integrated in the control unit or via the flexible FEHLMANN MCM™.



The experience in practical operation.

FEHLMANN AG
MASCHINENFABRIK, BIRREN 1, CH-5703 SEON / SWITZERLAND
TELEFON +41 62 769 11 11, FAX +41 62 769 11 90
mail@fehlmann.com, www.fehlmann.com

Guards could have been removed for better illustration. Subject to technical modifications.

Made in Switzerland

