

# TYA-Low Profile High Current SMT Power Inductor

## TYA4020 Series

### FEATURES AND APPLICATIONS

Laird TYA series high current power inductors improve performance, reliability and power efficiency. A lower profile benefits consumer electronics, industrial and telecom design. Products feature extremely low DCR with greater efficiency and enable a large current in a small size. Inductors are of magnetic shielding and wire wound construction and perform in operating temperatures ranging from -40 C to 125 C including self-heating rise in temperature.

#### FEATURES

- Magnetic shielded structure
- Low DCR and high efficiency
- Low profile and small size
- Metal alloy core with high saturation

#### APPLICATIONS

- DC-DC Converter and Power Suppliers
- LCD TV'S and Gaming Console
- Tablet, Notebooks, Servers and Printers
- Networking and Data storage
- GPS, Set-top-box and Base stations
- Smart meters and Medical instruments



#### PART NUMBER EXPLANATION

TYA 4020 4R7 M - 10

Product series code	Product size code	Inductance value code (i.e. 4R7: 4.7 $\mu$ H)	Tolerance % (i.e. M: $\pm$ 20%)	Standard Catalog P.N
---------------------	-------------------	--	------------------------------------	----------------------

#### ELECTRICAL SPECIFICATIONS

- Tolerance: M:  $\pm$ 20% or N:  $\pm$ 30%
- Inductance tested at 1MHz, 1.0Vrms
- Heat Rated Current (Irms) is defined based on temperature rise approximate 40°C (ambient temperature 25 $\pm$ 5°C)
- Saturation Current (Isat) is the DC current at which the inductance drops off approximately 30% from its value without current. (ambient temperature 25 $\pm$ 5°C)
- Operating temperature range: -40°C~+125°C (including self-heating temperature rise)
- Storage temperature range (packaging conditions): -10°C~+40°C and RH 70%(MAX.)

**Note:** Heat Rated Current (Irms) is tested on a typical PCB and apply a constant current in still air. The temperature rise is dependent on the application system condition including PCB PAD pattern, trace width and thickness and adjacent components etc. It's suggested to verify the temperature rise of the component under the real operation application conditions.

**SPECIFICATION**

**1.MECHANICAL & DIMENSIONS**

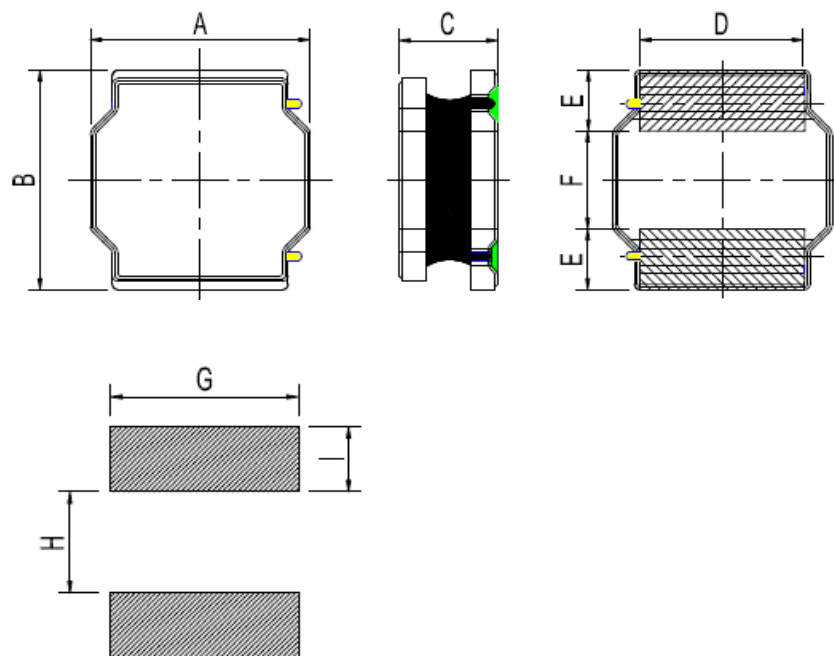

(UNIT: mm)

A	4.00±0.30
B	4.00±0.30
C	2.10 Max
D	3.30±0.30
E	1.00±0.20
F	2.00±0.30
G	3.7 REF
H	1.9 REF
I	1.1 REF

REMARK

**2.PART NUMBER NOMENCLATOR:**

TYA 4020 3R3 M - 10  
**A B C D E**

A: Product Series.

B: Series number, part size

C: Inductance code

D: Inductance Tolerance. (M=±20% ,N=±30%)

E: "X"=0:Standard catalog part number

"X"=1-9:Controlled customized part **or** different performance than std catalog part.

**3.EQUIVALENT CIRCUIT:**

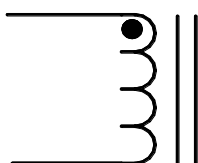

**SPECIFICATION**

PART NUMBER	INDUCTANCE (uH)	Irms(A) Typ.	Isat(A) Typ.	DCR(mΩ)Typ	DCR(mΩ) Max
TYA4020R24M-10	0.24	6.00	14.00	13.0	17.0
TYA4020R33M-10	0.33	5.90	13.00	15.0	20.0
TYA4020R47M-10	0.47	5.90	11.00	16.0	22.0
TYA4020R68M-10	0.68	5.80	9.00	19.2	24.5
TYA40201R0M-10	1.00	5.80	8.70	23.0	28.0
TYA40201R5M-10	1.50	5.20	7.70	32.0	38.0
TYA40202R2M-10	2.20	4.00	6.00	46.0	56.0
TYA40203R3M-10	3.30	3.40	4.70	73.0	88.0
TYA40204R7M-10	4.70	2.85	4.00	95.0	115.0
TYA40206R8M-10	6.80	2.40	3.00	130.0	160.0
TYA40208R2M-10	8.20	2.10	2.90	175.0	220.0
TYA4020100M-10	10.00	2.00	2.80	190.0	220.0
TYA4020150M-10	15.00	1.00	2.10	305.0	400.0
TYA4020220M-10	22.00	0.95	1.30	415.0	545.0
TYA4020330M-10	33.00	0.70	1.20	650.0	850.0
TYA4020470M-10	47.00	0.56	1.10	950.0	1200.0

**GENERAL SPECIFICATION:**

- 1, Test conditions(L): 1.0MHz, 1Vrms
- 2, Operating temperature: -40°C to +125°C (Including self-heating)
- 3, Storage temperature: -10°C to +40°C
- 4, Humidity range: 70% RH Max.
- 5, Heat Rated Current (Irms) will cause the coil temperature rise approximately Δt of 40°C
- 6, Saturation Current (Isat) will cause L0 to drop approximately 30%.
- 7, Part Temperature (Ambient+Temp. Rise) : Should not exceed 125°C under worst case conditions.
- 8, Storage condition (component in its packaging)

**SPECIFICATION**

**Characteristics Curve**

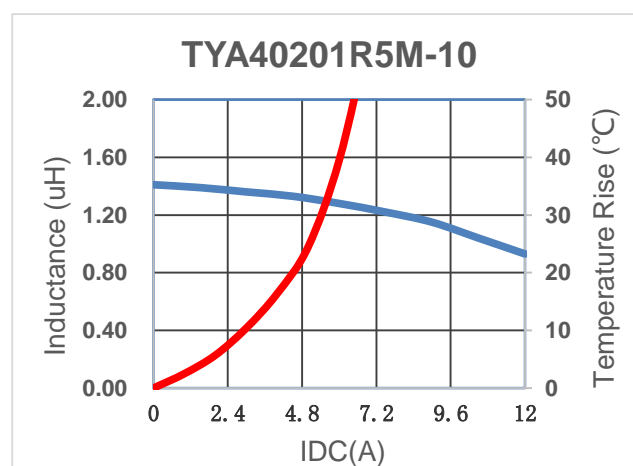
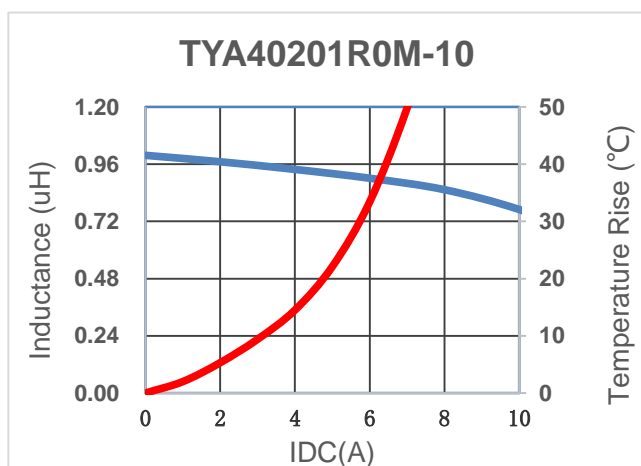
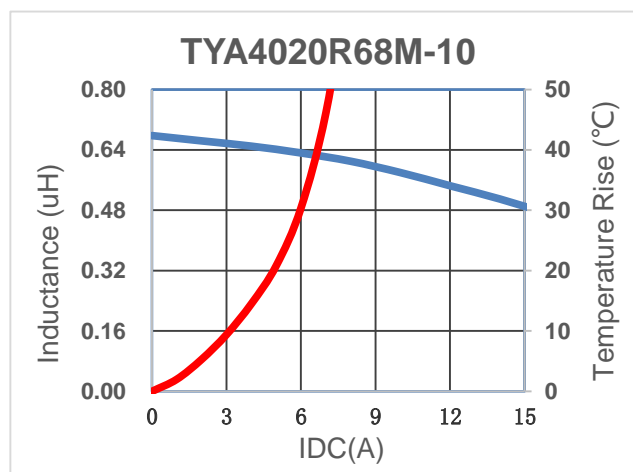
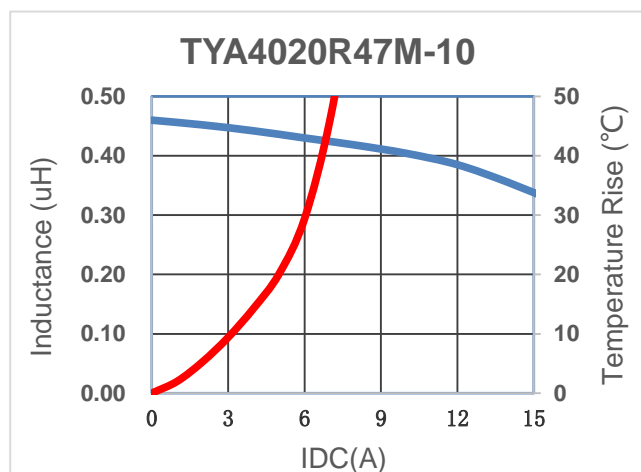
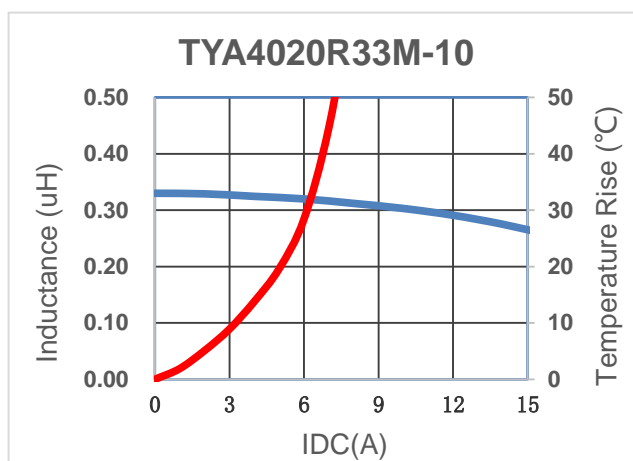
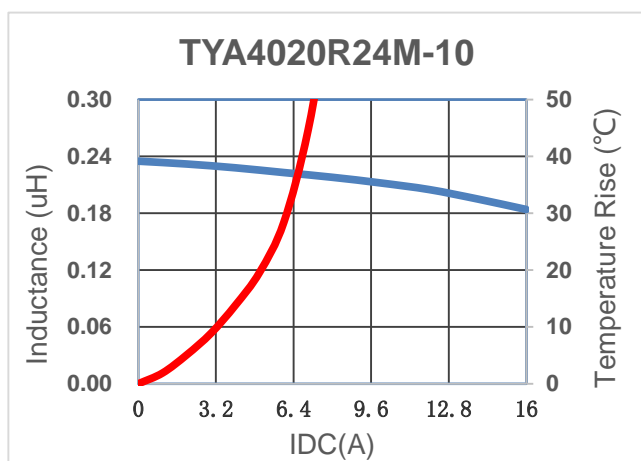

**SPECIFICATION**

**Characteristics Curve**

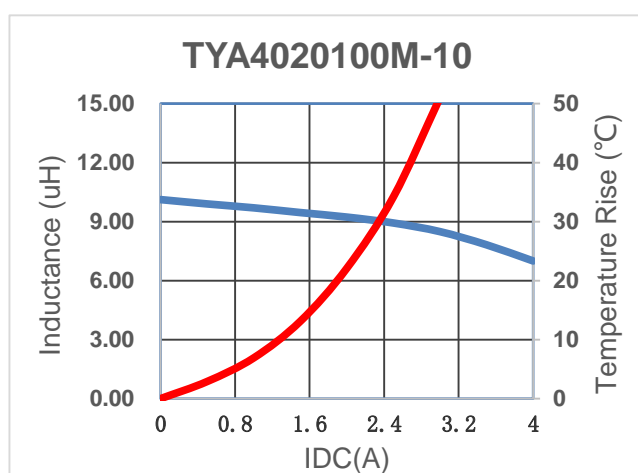
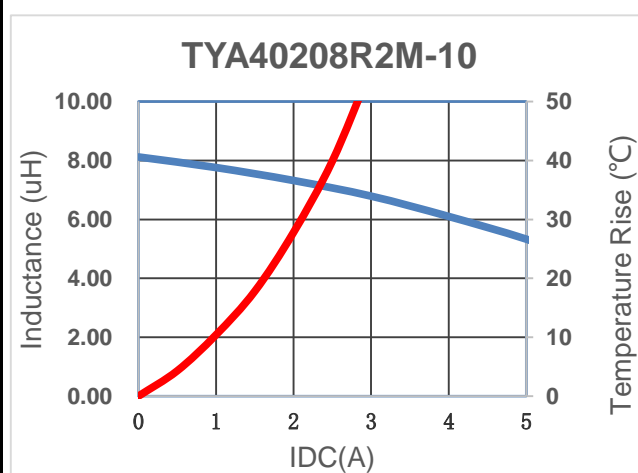
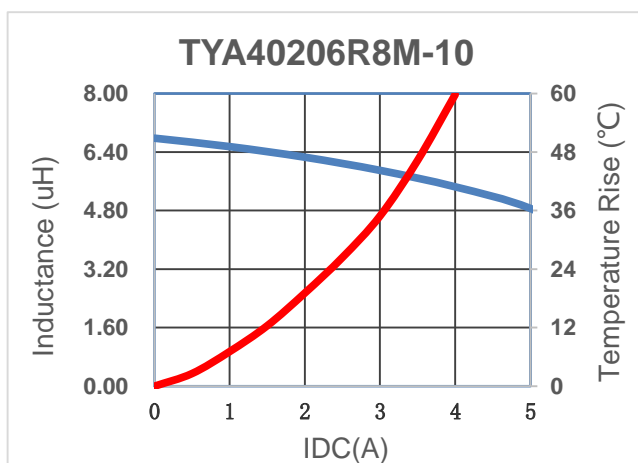
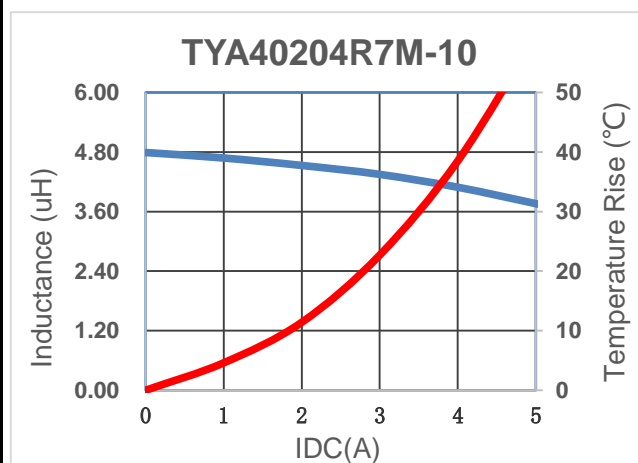
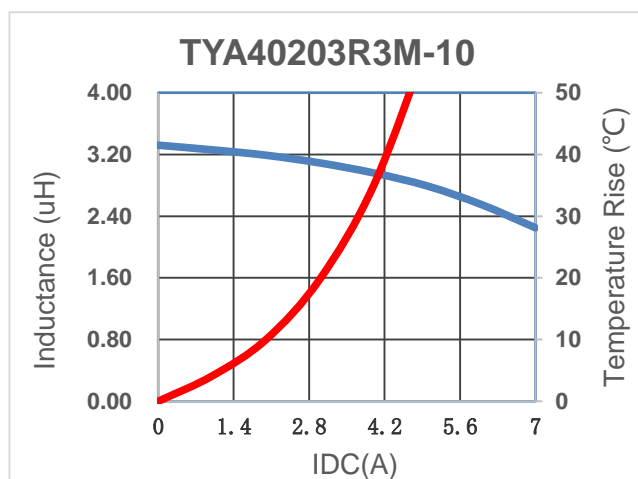
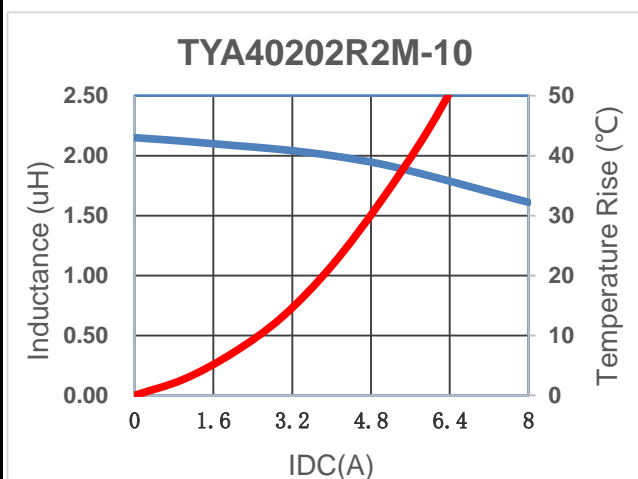

**SPECIFICATION**

**Characteristics Curve**

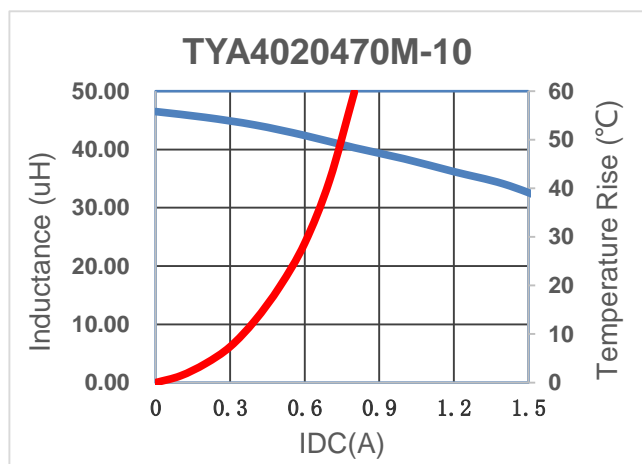
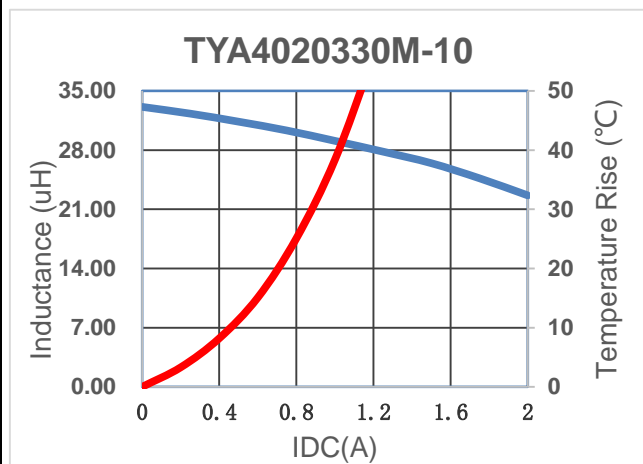
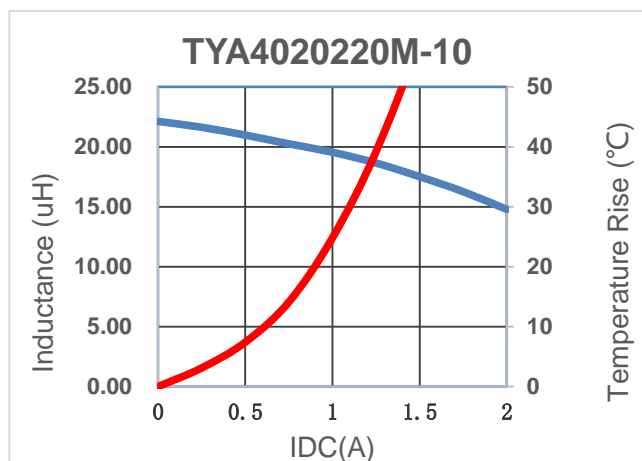
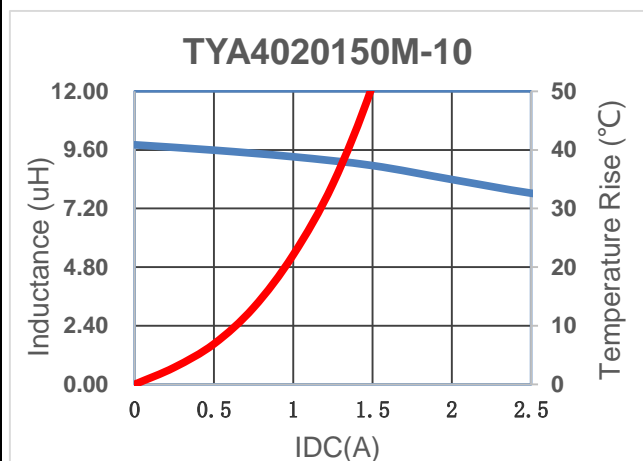

**Recommended Soldering Conditions**

■ For Lead-Free Application

Figure 1 . Re-flow Soldering

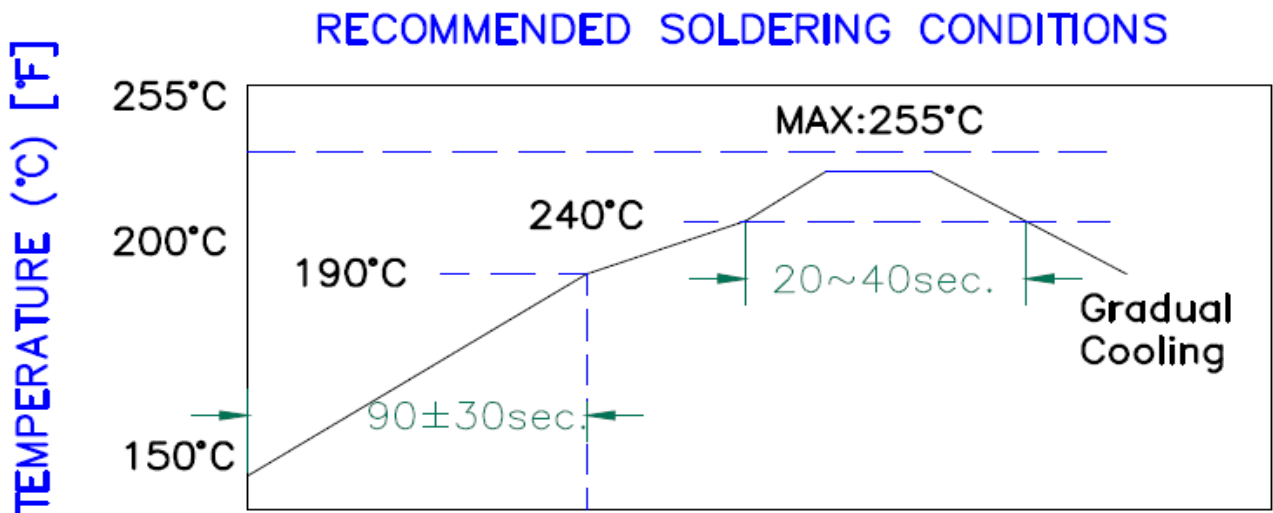

**Reliability and Testing Conditions / Pin Type Power Inductors**

**SMD series(Consumer)**

Item	Reference	Additional Requirements
Operating temperature range	-40°C ~ +125°C (Including self-temperature rise)	
Storage temperature and humidity range	-10°C to +40°C , 70% RH Max	
High Temperature Exposure (Storage)	MIL-STD-202 Method 108	85±2°C, 168+24hours
Temperature Cycling	JESD22 Method JA-104	-40°C → +85, transforming interval:20s, 100cycles
Operational Life	MIL-PRF-2	85±°C, 168+24hours Apply maximum rated voltage and current according part drawing
External Visual	MIL-STD-883 Method 2009	Inspect device construction, marking and workmanship. Electrical Test not required.
Physical Dimension	JESD22 Method JB-100	Verify physical dimensions to the applicable device detail specification. Note: User(s) and Suppliers spec. Electrical Test not required
Vibration	MIL-STD-202 Method 204	10~55Hz,1.5mm, 2 hours in each 3mutually perpendicular directions (total of 6 hours)
Resistance to Soldering Heat	MIL-STD-202 Method 210	1. Max. 260±5°C,10±1s, 2 times 2.Solder Composition: Sn/3Ag/0.5Cu
Solderability	J-STD-002	245±5°C, 5±1sec, Solder: Sn/3.0Ag/0.5Cu
Electrical Characterization	Print Spec	Parametrically test per lot and sample size requirements, summary to show Min, Max, Mean and Standard deviation at room as well as Min and Max Operating temperatures
Board Flex	AEC-Q200-005	2mm,30±1s
Terminal Strength(SMD)	AEC-Q200-006	10N, 5S, X,Y direct



**PACKAGING**

**Reel Dimension**

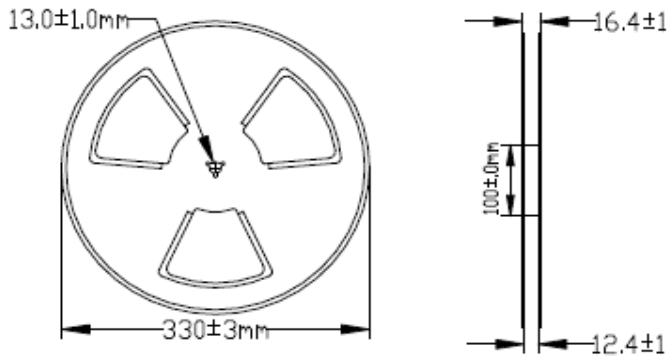

**Tape Dimension**

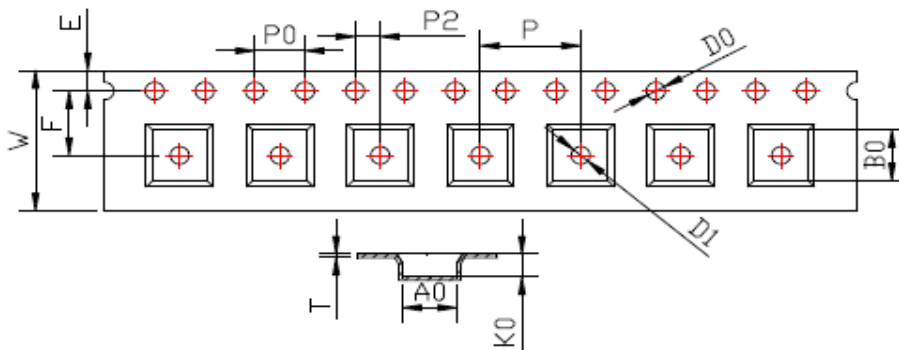

ITEM	W	A0	B0	K0	P	F	E	D0	D1	P0	P2	T
DIM	12.00	4.3	4.3	2.25	8.00	5.50	1.75	1.50	1.50	4.00	2.00	0.30
TOLE	+0.30 -0.10	±0.1	±0.1	±0.1	±0.1	±0.1	±0.1	+0.1	+0.1	±0.1	±0.1	±0.05

**Packaging Quantity**

P/N	Chip/Reel	Inner Box	Outer Box
TYA4020 series	3000pcs	6000pcs	12000pcs
Size	-	-	-

**Peeling Off Force**

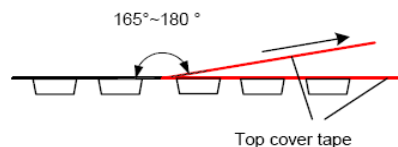

The force peeling off cover tape is 10 to 100 grams in the arrow direction under the following conditions			
Room Temp	Room Humidity (%)	Room atrn (hPa)	Teaming Speed (mm/min)
5~35	45~85	860~1060	300

**※Storage Conditions**

1. Temperature and humidity conditions: -10~+40°C and 70% RH.
2. Recommended products should be used within 12 months from the time of manufacturing.
3. The packaging material should be kept where no chlorine or sulfur exists in the air.
4. Allowable stacking condition of Packaging box: max height 1.5m or 5 boxes stacking

# Mouser Electronics

Authorized Distributor

Click to View Pricing, Inventory, Delivery & Lifecycle Information:

## Laird Performance Materials:

[TYA40203R3M-10](#) [TYA4020470M-10](#) [TYA40204R7M-10](#) [TYA40201R0M-10](#) [TYA4020150M-10](#) [TYA40201R5M-10](#)  
[TYA4020330M-10](#) [TYA4020220M-10](#) [TYA40206R8M-10](#) [TYA4020100M-10](#) [TYA40202R2M-10](#) [TYA4020R68M-10](#)